

概述

BNC系列射频同轴连接器是应用较早也是较广泛的连接器之一，卡口式锁定机构，能快速插接及分离。并有弹圈防震设计，确保震动环境中可靠连接，其特性阻抗为50Ω及75Ω。

BNC系列连接器符合GJB 681A-2002、MIL-C-39012、IEC 60169-8 等技术标准。

主要技术特性

温度范围 Temperature range		-65℃ ~ +165℃	绝缘电阻 Insulation resistance	≥5000MΩ
特性阻抗 Characteristic impedance		50Ω	介质耐压 Dielectric withstanding voltage	1500V(rms)
频率范围 Frequency range		0GHz~4GHz	电压驻波比 VSWR	≤1.30
工作电压 Voltage rating		500V(rms)	分离力 Disengage force	≥0.6N
接触电阻 Contact resistance	中心导体 Center conductor	≤0.0015Ω	寿命 Durability	500 Cycles
	外导体 Outer conductor	≤0.0002Ω		

头部配合尺寸 INTERFACING DIMENSIONS

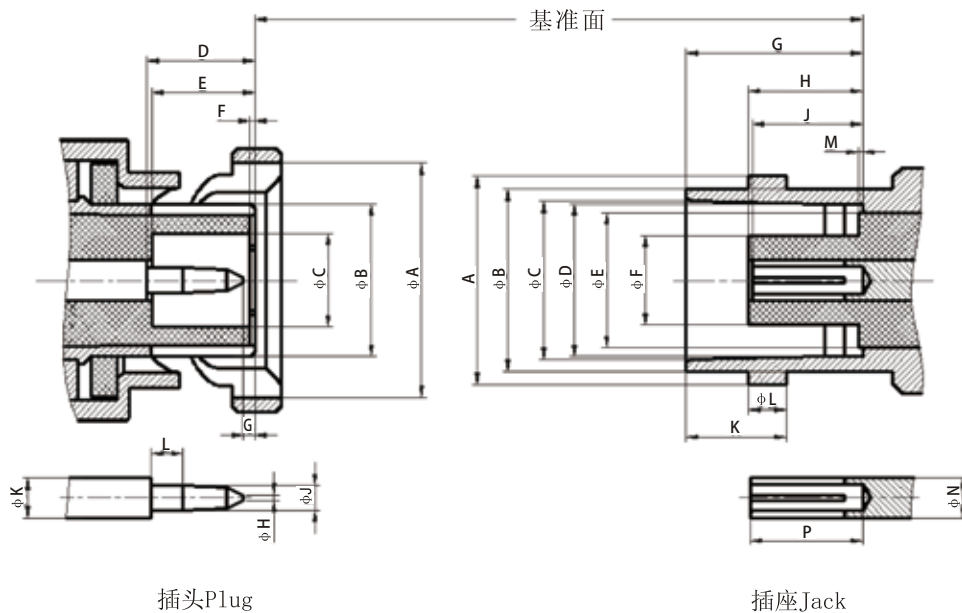

BNC系列射频同轴连接器



PLUG (mm)			JACK (mm)		
Symbol	MIN	MAX	Symbol	MIN	MAX
A	9.78	9.91	A	10.97	11.07
B	-	-	B	9.60	9.70
C	4.83	-	C	8.31	8.46
D	5.33	5.84	D	8.10	8.15
E	5.28	5.79	E	-	6.50
F	0.15	0.46	F	-	4.72
G	0.08	1.02	G	8.31	8.51
H	-	0.64	H	4.78	5.28
J	1.32	1.37	J	4.72	5.23
K	2.06	2.21	K	5.18	5.28
L	1.98	-	L	1.91	2.06
			M	-	0.15
			N	2.06	2.21
			P	4.95	-

电缆连接器



BNC-J3等

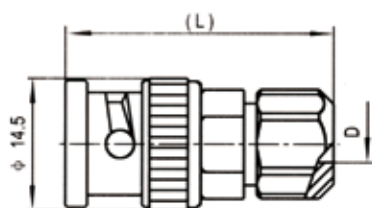

Type	D	L	Cable type
BNC-J3A	φ 3.1	31.1	SFF-50-1.5-1 SYV-50-2-1
BNC-J4A	φ 4.2	31.1	SFF-50-2-2 SYV-50-2-2
BNC-J5A	φ 5.5	31.1	SYV-50-3



BNC-J5T

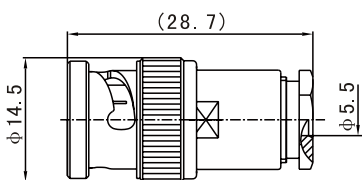

Type	Cable type
BNC-J5T	SYV-50-3



BNC-JW3A等

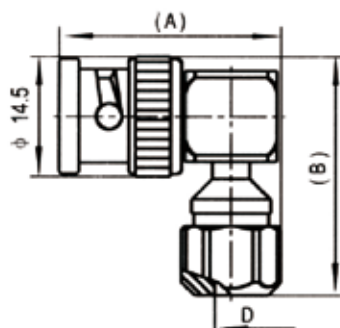

Type	D	A	B	Cable type
BNC-JW3A	φ 3.1	26	27.4	SYV-50-2-1 SFF-50-1.5-1
BNC-JW4A	φ 4.2	26	27.4	SYV-50-2-2 SFF-50-2-2
BNC-JW5A	φ 5.5	26	27.4	SYV-50-3

BNC系列射频同轴连接器



BNC-JW27A

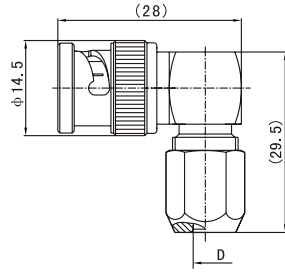

Type	D	Cable type
BNC-JW27A	Φ 7.4	SYV-50-5-1



BNC-JW3等

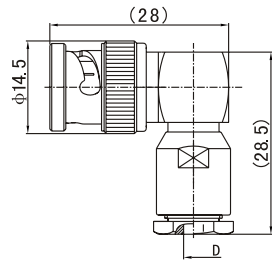

Type	D	Cable type
BNC-JW3	Φ 3.1	SYV-50-2-1 SFF-50-1.5-1
BNC-JW4	Φ 4.2	SYV-50-2-2 SFF-50-2-2
BNC-JW5	Φ 5.5	SYV-50-3



BNC-J2Y

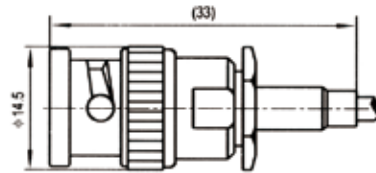

Type	Cable type
BNC-J2Y	SFF-50-1 SYV-50-1



BNC-J3Y

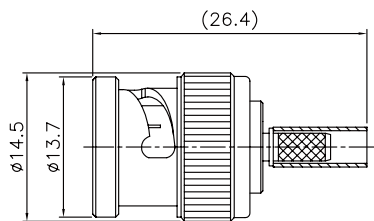

Type	Cable type
BNC-J3Y	SFF-50-1.5-1 SYV-50-2-1



BNC-J4Y等

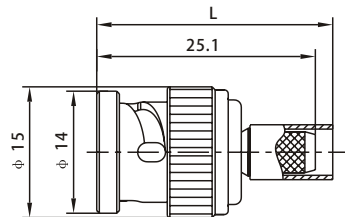

Type	L	Cable type
BNC-J4Y	26.6	SFF-50-2-2 SYV-50-2-2
BNC-J5Y	27.1	SYV-50-3, RG58C/U

BNC系列射频同轴连接器



BNC-J240Y

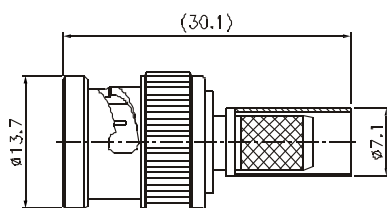

Type	Cable type
BNC-J240Y	LMR-240/UF



BNC-J400Y

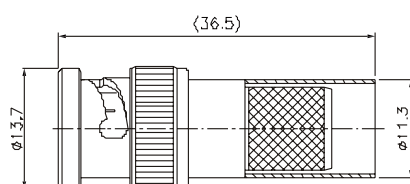

Type	Cable type
BNC-J400Y	LMR-400/UF



BNC-K400Y

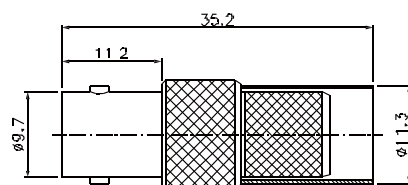

Type	Cable type
BNC-K400Y	LMR-400/UF



BNC-JW4Y等

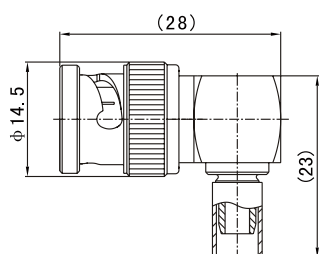

Type	Cable type
BNC-JW3Y	SYV-50-2-1 SFF-50-1.5-1
BNC-JW4Y	SYV-50-2-2 SFF-50-2-2
BNC-JW5Y	SYV-50-3

BNC系列射频同轴连接器



BNC-KY2Y等

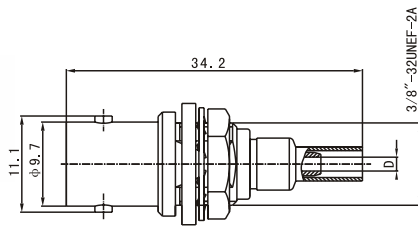

安装开孔尺寸
Mounting hole

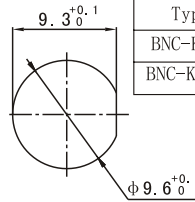

Type	D	Cable type
BNC-KY2Y	$\phi 1$	SFF-50-1、SYV-50-1
BNC-KY3YA	$\phi 1.6$	SFF-50-1.5-1、SYV-50-2-1



BNC-KY5YA

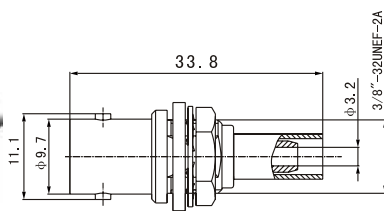

安装开孔尺寸
Mounting hole

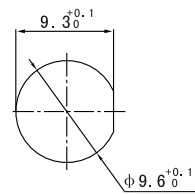

Type	Cable type
BNC-KY5YA	SYV-50-3



BNC-KY3Y

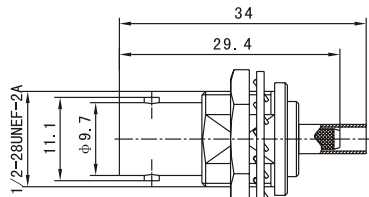

安装开孔尺寸
Mounting hole

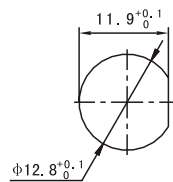

Type	Cable type
BNC-KY3Y	SFF-50-1.5-1 SYV-50-2-1



BNC-KF3Y

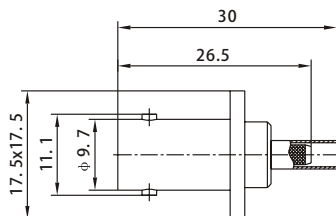

安装开孔尺寸
Mounting hole

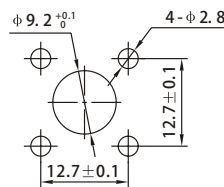

Type	Cable type
BNC-KF3Y	SFF-50-1.5-1 SYV-50-2-1

BNC系列射频同轴连接器



面板连接器



BNC-50KY-4

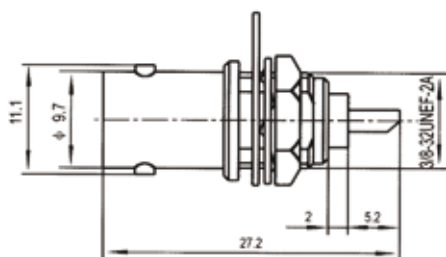

安装开孔尺寸
Mounting hole

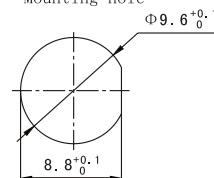

BNC-50KY-5

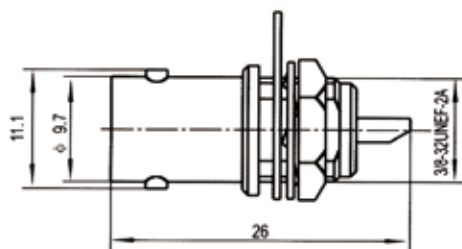

安装开孔尺寸
Mounting hole

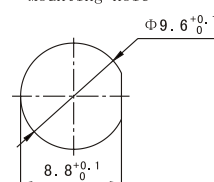

BNC-50KY-6

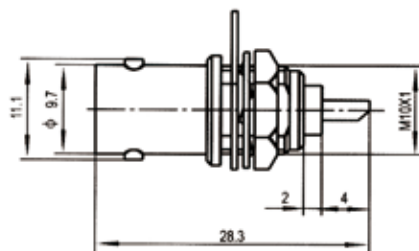

安装开孔尺寸
Mounting hole

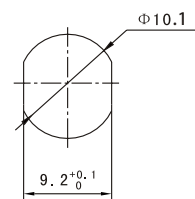

BNC-50KY-7

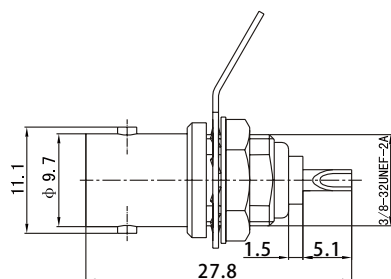

安装开孔尺寸
Mounting hole

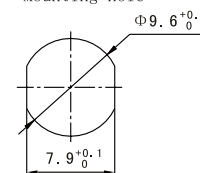

BNC(M)-50KY-8

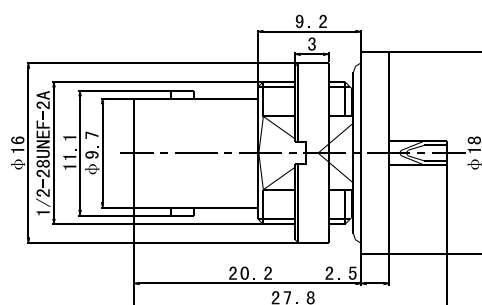

安装开孔尺寸
Mounting hole

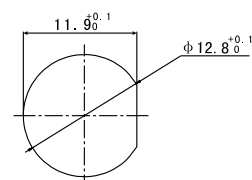

BNC系列射频同轴连接器



BNC-50KFD

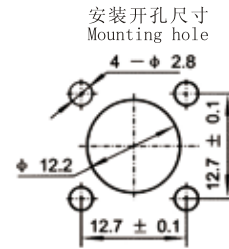
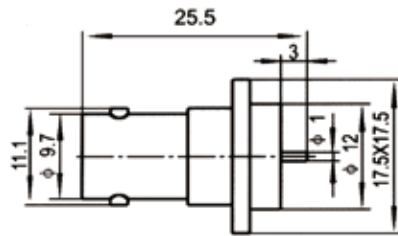

BNC-50KF

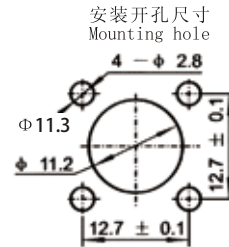
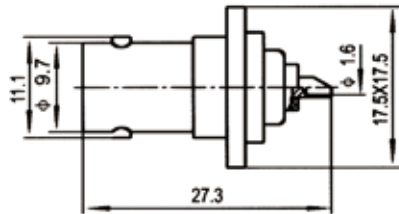

BNC(M)-50KF

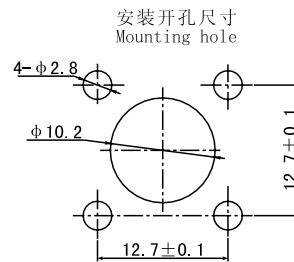
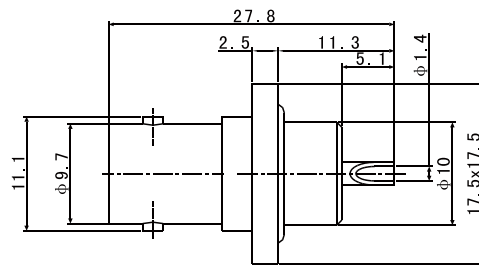

BNC-KHD

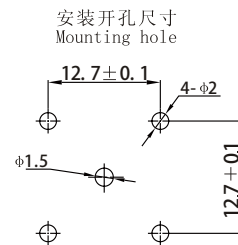
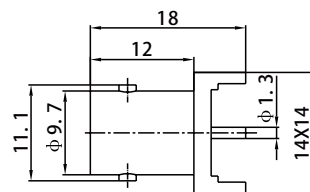

BNC-KHD1

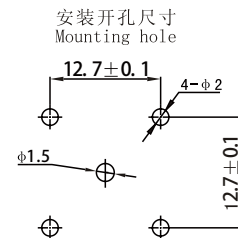
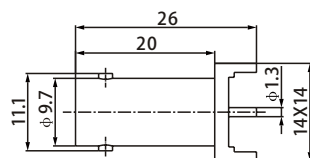

BNC75系列射频同轴连接器



概述

BNC75系列射频同轴连接器具有卡口锁定机构，能快速插接及分离，并有弹圈防震设计，确保震动环境中可靠连接，其特性阻抗为75Ω。

BNC75系列射频同轴连接器适用标准为GJB 681A-2002、MIL-C-39012、IEC 60169-8等。

主要技术特性

温度范围 Temperature range	-65℃~+165℃	工作电压 Voltage rating	500V(AC)
特性阻抗 Characteristic impedance	75Ω	绝缘电阻 Insulation resistance	≥5000MΩ
频率范围 Frequency range	0GHz~1GHz	介质耐压 Dielectric withstanding voltage	1500V(AC)
接触电阻 Contact resistance	中心导体 Center conductor	电压驻波比 VSWR	≤1.3
	外导体 Outer conductor	寿命 Durability	500 Cycles

头部配合尺寸 INTERFACE MATING DIMENSIONS

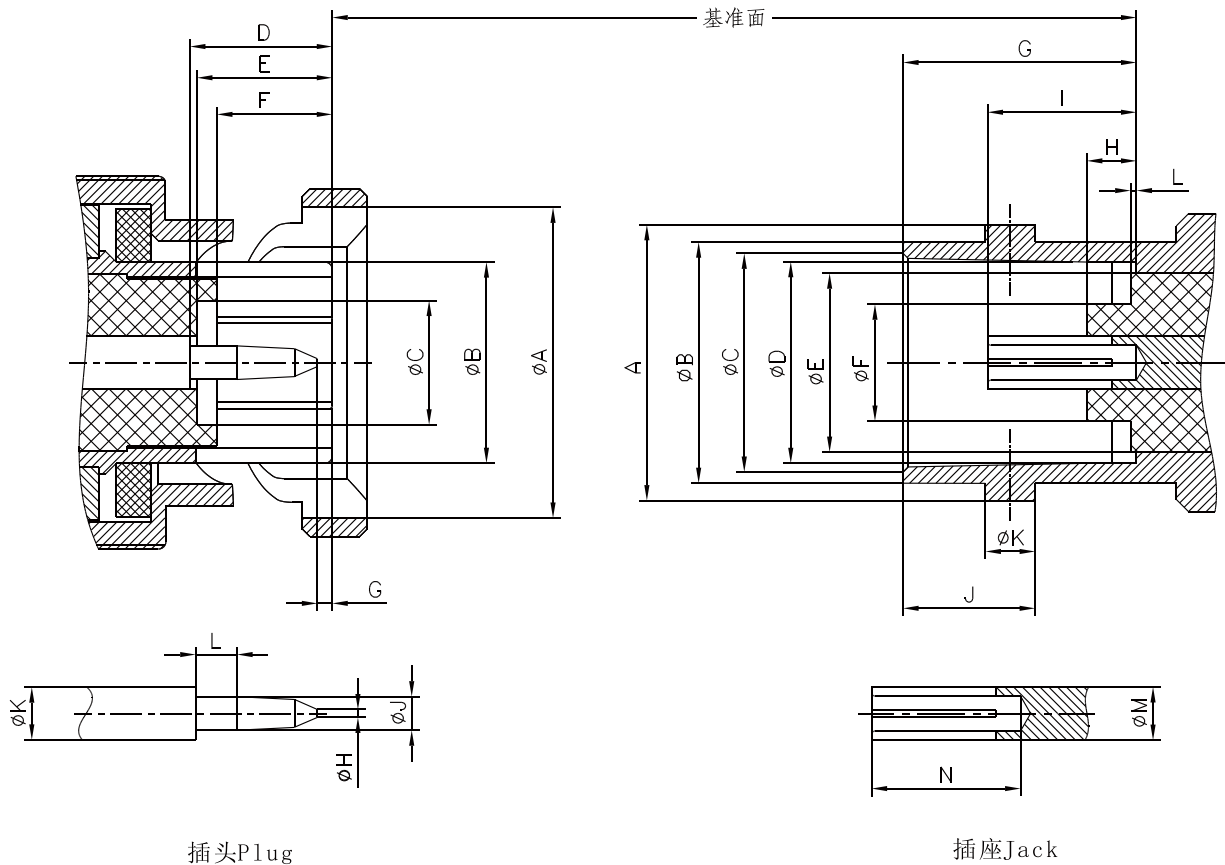

BNC75系列射频同轴连接器

PLUG (mm)			JACK (mm)		
Symbol	MIN	MAX	Symbol	MIN	MAX
A	9.78	9.91	A	10.97	11.07
B	-	-	B	9.609.70	9.70
C	4.83	4.83-	C	8.799.04	9.04
D	5.33	5.33-	D	8.10	8.15
E	5.28	5.79	E	-	6.50
F	1.30	5.30	F	-	4.72
G	0.08	1.02	G	8.31	8.51
H	-	0.64	H	4.95	-
I	-	-	I	4.72	5.23
J	1.32	1.37	J	5.18	5.28
K	2.06	2.21	K	1.91	2.06
L	1.98	-	L	-	0.15
M	-	-	M	1.88	2.29
N	-	-	N	4.95	-

电缆连接器



BNC-75J12T

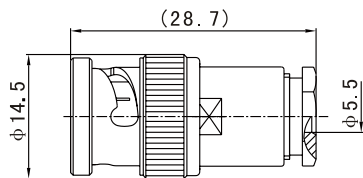

Type	Cable type
BNC-75J12T	SYV-75-3

面板连接器



BNC-75KF-5

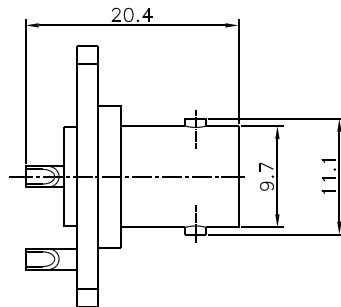

安装开孔尺寸
Mounting hole

